

Flexible and sensitive 2D optical imaging in a benchtop format.

The IVIS® Lumina S5 combines best in class high throughput 2D *in vivo* bioluminescence and fluorescence imaging into a compact system that fits easily on a benchtop. With an expanded field of view for 2D optical imaging plus our unique line of accessories to accelerate setup, it has never been easier or faster to get robust data - and answers - on anatomical and molecular aspects of disease. The IVIS Lumina S5 also includes state of the art spectral unmixing features for sensitive multispectral imaging to monitor multiple biological events in the same animal.

Key features

- Large field of view enabling imaging of up to 10 mice*
- Optional Smart animal handling accessories increasing throughput and streamlining imaging workflow
- Spectral unmixing for sensitive multispectral imaging for monitoring multiple biological events
- Full fluorescence tunability through the NIR spectrum
- High sensitivity 2D bioluminescence imaging
- Software wizard for simplified experimental workflow

Improve productivity with high-throughput optical

The IVIS Lumina S5 integrates a one inch CCD camera into our benchtop instrument providing a high-throughput 22.5 x 22.5 cm FOV sufficient for imaging 5 animals at a time with bioluminescence and fluorescence (Figure 1) or up to 10 mice with optional manifold.

IVIS® Lumina S5

*Using optional manifold

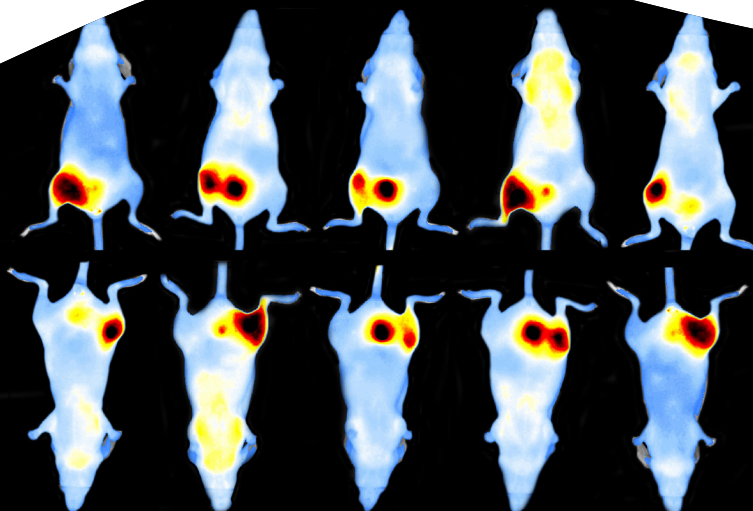

As with other IVIS Lumina systems, the IVIS Lumina S5 is equipped with 26 filters tunable to image fluorescent sources that emit from green to near-infrared. Novel illumination technology using our extended NIR range Tungsten lamp, increases fluorescent transmission through 900 nm. Moreover, the IVIS Lumina S5 incorporates our patented Compute Pure Spectrum (CPS) algorithm for spectral library generation software tools to ensure accurate autofluorescence removal, unmixing and fluorophore quantitation.

Standard on all IVIS instruments, absolute calibration affords consistent and reproducible results independent of magnification, filter selection, or acquisition settings from one instrument to any IVIS instrument within an organization or around the world.

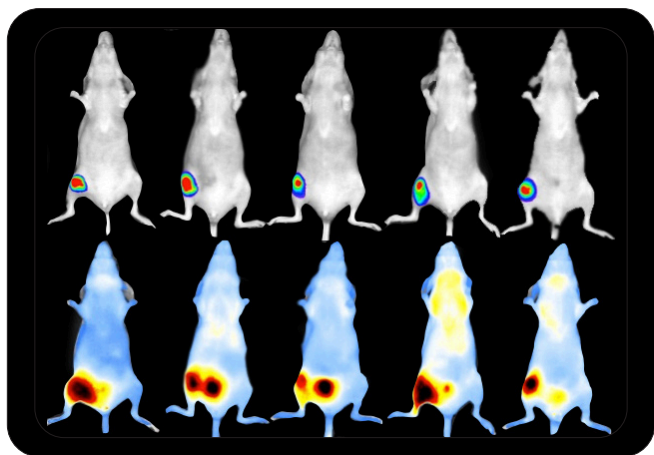

Figure 1: IVISbrite™ 4T1 Red F-luc bioluminescent tumor cells injected subcutaneously into flank and imaged on the IVIS Lumina S5. (Top) Bioluminescent signal acquisition, (bottom) fluorescence detection of IVISense™ Integrin Receptor 750 probe accumulation at tumor site.

Simplified workflow

Not only does the IVIS Lumina S5 offer higher throughput imaging via the one inch CCD, but it is also compatible with a set of Smart animal handling accessories (purchased separately) designed with throughput and safety in mind.

Smart loading trays (Figure 2) enable users to pose animals on the benchtop before placing the tray into the IVIS. Using fiducials built into the tray, the software can automatically recognize and draw ROIs providing automated animal identification.

Animal trays are designed with ease of use and user safety in mind. No nose cones are required thus minimizing cleanup. All tray parts have been tested and are resistant to repeated use with common laboratory disinfectants. Furthermore capabilities minimize excess gas from escaping thus preventing exposure of users to anesthetic gas.

Finally, Living Image® software brings IVIS technology to life by facilitating an intuitive workflow for *in vivo* optical analysis and data organization. The software will support input of unique animal IDs when using chip technologies and readers from third party vendors thus streamlining labeling, setup and subsequent export of data for analysis

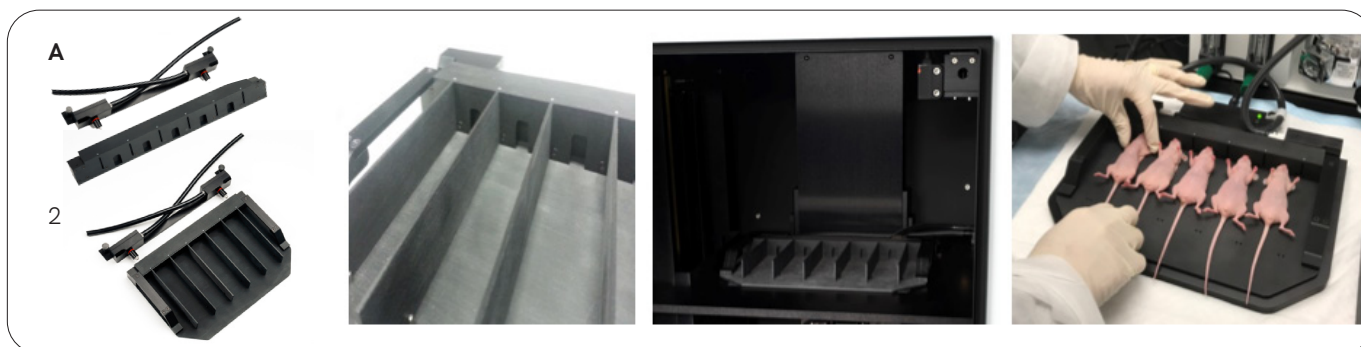

Figure 2: Smart Animal Management accessories were designed with safety, ease of use and speed of acquisition in mind. A quick connect anesthesia port and 5 mouse/2 rat manifold come standard with the IVIS Lumina S5 (A1). The high throughput five mouse tray (purchased separately) connects seamlessly to the supplied quick connect port (a2). The ergonomic tray design does not require nose cones; new baffles securely isolate signal for data integrity; and fiducials present in the tray allow automatic subject recognition during image acquisition (B). The tray can connect either inside the IVIS (C) or it can be used for prepositioning animals (D) on the benchtop when used in conjunction with the benchtop posing station (sold separately).

Improve productivity with high-throughput optical

Excitation Filter Ranges (nm)	Emission Filter Ranges (nm)	Common Dyes / Agents / Reporters
410-430	500-540	IVISense™ targeted, vascular, & activatable probes
430-450	550-590	IVISense dyes
450-470	600-640	IVISense self-quenching dyes
470-490	650-690	IVISense cell labeling dyes
490-510	690-730	Alexa Fluor® 600-750
510-530	770-810	Cy5-Cy7.5
530-550	825-865	DsRed, Doxorubicin**
550-570		mCherry**
570-590		tdTomato**
590-610		GFP*
610-630		FITC*
630-650		ICG
650-670		
670-690		
690-710		
710-730		
730-750		
750-770		
770-790		

* Best used with *in vitro*, *ex vivo* and surface imaging techniques

** Enhanced quantification with Spectral Unmixing

Inside the IVIS Lumina S5

- Back-illuminated, thermoelectric cooled 2.7 x 2.7 cm grade 1 CCD provides high quantum efficiency over the entire visible to near-infrared spectrum
- Light-tight imaging chamber
- 19 excitation filters and eight emission filters support CPS spectral unmixing
- LED lamps for photographic images
- Heated stage to maintain optimum body temperature
- Motor controlled stage, filter wheels, lens position, and f-stop

Optional Accessories

- Smart animal handling tray to accelerate setup, labeling and analysis with benchtop posing accessory
- Heavy duty workbench with integrated keyboard tray and monitor stand.
- MVI-2™ for 360 degree surface mapping

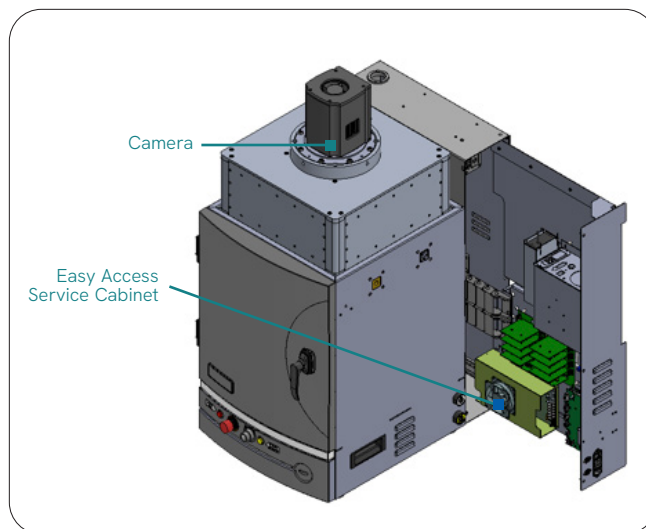

Figure 3. Diagram of external features of IVIS Lumina S5.

IVIS Lumina platform system accessories – Expand your IVIS Lumina Instrument with features when you need them!



Smart high throughput imaging kit
CLS148874



MVI-2 Module for 360 degree
surface mapping CLS143807



RAS-4 Rodent anesthesia system
CLS146737

The IVIS Lumina platform offers a selection of instruments tailored to your *in vivo* imaging needs

Features	IVIS Lumina LT	IVIS Lumina III	IVIS Lumina XRMS	IVIS Lumina S5	IVIS Lumina X5
Capacity	Up to 5 mice*	Up to 5 mice*	Up to 3 mice	Up to 10 mice**	Up to 10 mice**
1.3 x 1.3 cm CCD - 90°C	✓	✓	✓		
2.7 x 2.7 cm CCD - 90°C				✓	✓
2D Bioluminescence	✓	✓	✓	✓	✓
2D Fluorescence	✓	✓	✓	✓	✓
Enhanced fluorescence		✓	✓	✓	✓
Extended range 150 W Tungsten EKE	✓	✓	✓	✓	✓
Narrow bandpass excitation filters Supporting CPS Spectral Unmixing		✓	✓	✓	✓
Standard X-ray Package			✓		
High-Resolution X-ray					✓
Mouse tray with automatic subject recognition (optional)				✓	✓





* Using expansion lens

**Using optional manifold kit

Table 2. IVIS Lumina S5 Specifications

Imaging system components:	Specifications
Camera sensor	Back-illuminated thermoelectric, cooled Grade 1 CCD
Ccd size	2.7 x 2.7 cm
Ccd operating temperature	-90°C
Imaging pixels	2048 x 2048
Quantum efficiency	>85% at 500 nm, >80% at 650 nm
Pixel size	13.5 microns
Optical field of view (fov)	10 x 10, 15 x 15, 22.5 x 22.5 cm
Lens	f/1 - f/8
Minimum image pixel resolution	50 microns
Minimum read noise (e ⁻)	2e ⁻ RMS for Bin 1
Dark current	< 0.0008e ⁻ /pix/sec
Illumination source	Extended NIR Range 150W Tungsten EKE
Excitation fluorescence filters, number/ range	19 hard-coated narrow band pass filters
Emission fluorescence filters, number/range	7
Imaging system space requirement	48 x 69 x 122 cm (W x D x H)
Imaging chamber interior dimension	37 x 37 x 43 cm (W x D x H)
Power requirements	3.0A max @ 100-127 Vac, 50-60 Hz (± 10%) 1.5A max @ 200-240 Vac, 50-60 Hz (± 10%)
Stage temperature	20-40 °C
Computer (minimum specifications)	Windows® 10, 4 GB RAM, nVidia Quadro 600, 250 GB and 1 TB HD, 24" widescreen LED Monitor
Living image® software	Included with IVIS purchase

In Vivo Imaging Solutions

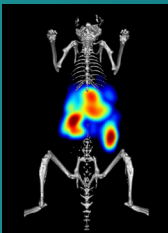
	Optical		MICRO-CT	Ultrasound	Reagents
					
<p>IVIS® Lumina Series III</p> <ul style="list-style-type: none"> • 2D optical imaging • Imaging up to 5 mice • Optional integrated x-ray 	<p>IVIS® Lumina S5 & X5</p> <ul style="list-style-type: none"> • 2D optical imaging • Imaging of up to 10 mice using optional manifold • Optional integrated high-resolution x-ray • Optional Smart accessories to streamline imaging workflow • MVI-2 for automated 360 degree imaging 	<p>IVIS® Spectrum 2 Series</p> <ul style="list-style-type: none"> • 2D & 3D optical imaging • Imaging of up to 10 mice using optional manifold • Fully automated, one-click co-registration with IVIS SpectrumCT • Seamlessly co-register 3D optical and hi-res microCT data • Two powerful modes of fluorescence excitation—epi- and trans- illumination 	<p>Quantum GX3</p> <ul style="list-style-type: none"> • High-resolution, low-dose microCT • Cardiac & respiratory gating 	<p>Vega®</p> <ul style="list-style-type: none"> • Automated, hands-free • High-throughput 3 mice imaging • Scan times in < 1 minute • Whole body field of view • Multiple 3D imaging modes <ul style="list-style-type: none"> • Elastography (tissue stiffness) • B-mode (soft tissue imaging) • 4D B-mode/M-mode (cardiac imaging) • Acoustic angiography (microvessel networks) 	<p>IVISbrite™</p> <ul style="list-style-type: none"> • Bioluminescent substrates, cells, and lentiviral particles <p>IVISense™</p> <ul style="list-style-type: none"> • Fluorescent probes, labels, and dyes <p>VesselVue®</p> <ul style="list-style-type: none"> • Microbubble contrast agent for vascular ultrasound imaging

